

# INSTRUCTION MANUAL

## COMMERCIAL-GRADE WATER CHILLERS



- ▶ ***Instruction manual***
  - ***Safety precautions and warnings***
  - ***Operation and maintenance of machine***
  - ***Terms of warranty***

## Index

1. Features
2. Safety precautions and warnings
3. Technical specifications
4. How to select the right machine
5. Performance curve
6. Installation
7. Operation
8. Maintenance
9. Circuit diagram
10. Troubleshooting
11. Warranty

Please read the instruction manual carefully and keep it for further reference.



## Features

Thanks for choosing this EcoPlus water chiller. This product is designed for both horticulture and marine water.

- Panasonic or Toshiba compressor with excellent durability and low noise. Extremely energy efficient.
- Finned condenser produced in the U.S.
- Aluminum radiator made with the aluminum imported from Japan that is coated with anti-corrosive paint.
- High-quality and anti-corrosive industrial heat exchanger made of pure titanium, which is suitable for fresh and marine water, and acid and alkaline solution.
- This machine is controlled by a micro computer and is easily operated with the control panel or with the 30 ft long cord remote.



## Safety Precautions and Warnings

### Warning symbols:

warning	prohibition	caution	protection



### Warning:

For safety use, the operation instruction below should be strictly followed.

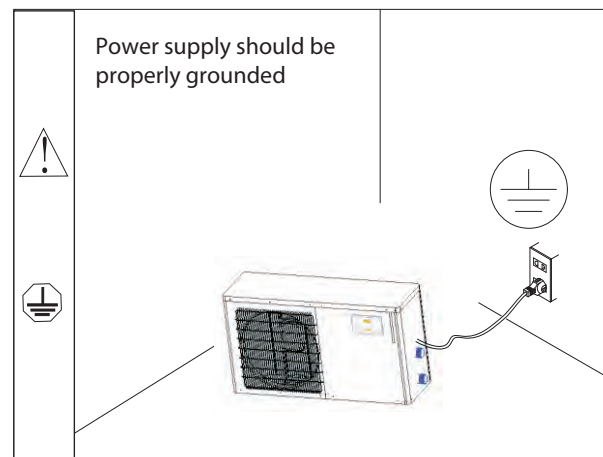
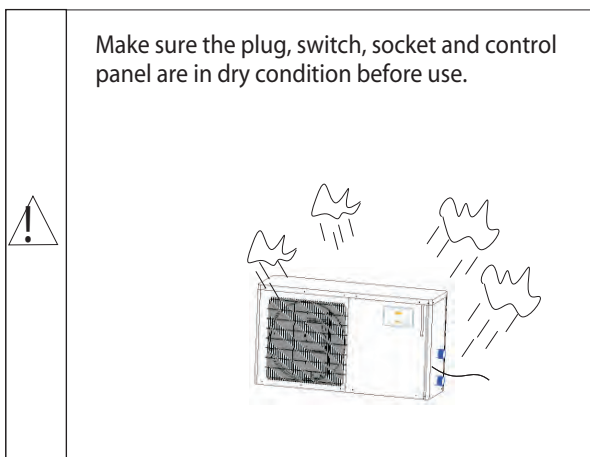



# Safety Precautions and Warnings

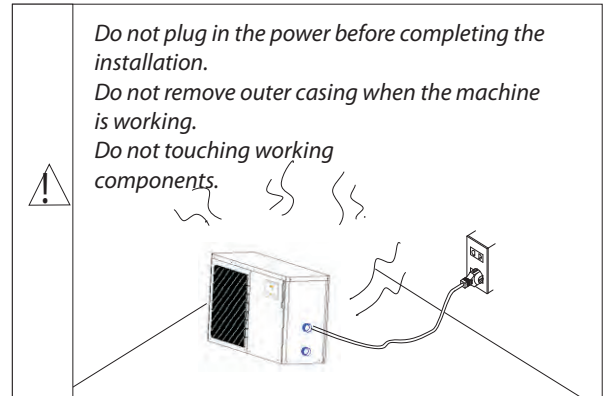
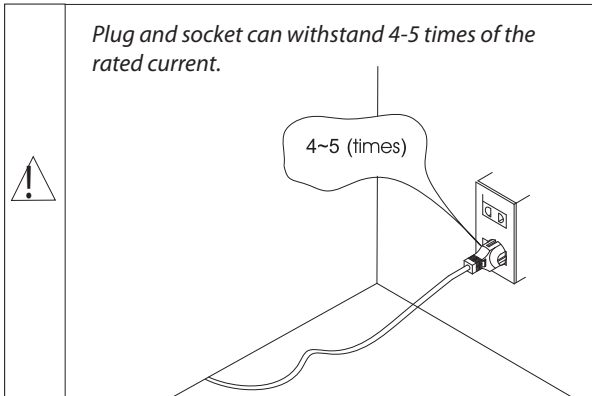

## ! Caution

To keep machine normal working, the below should be strictly followed:

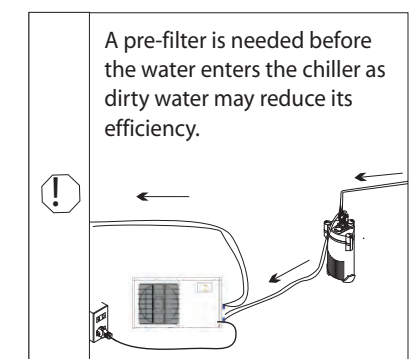
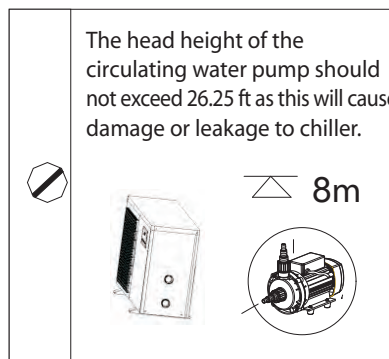
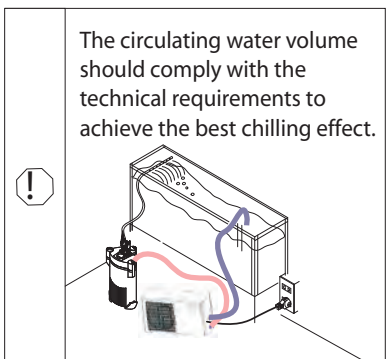
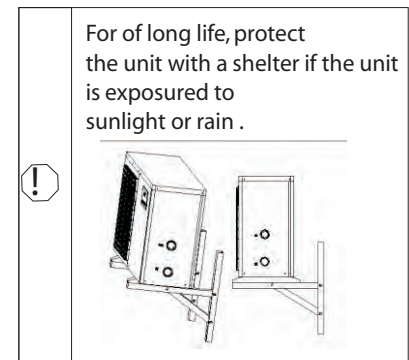
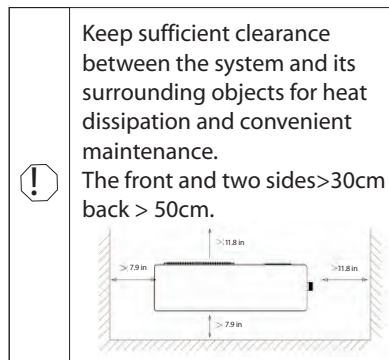
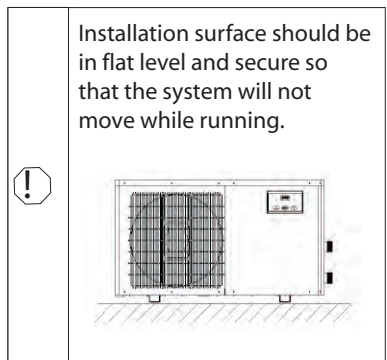
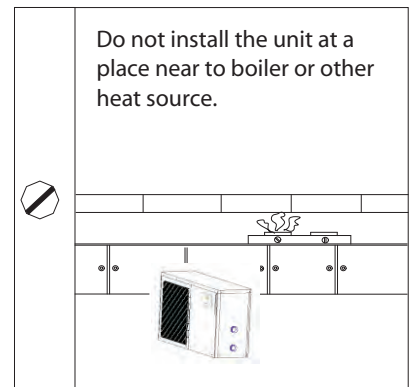
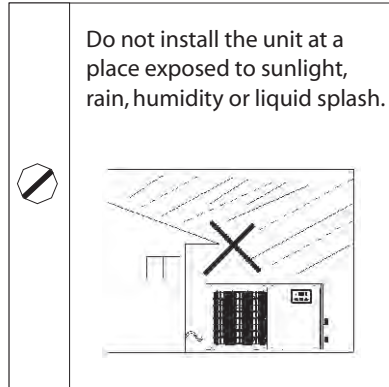
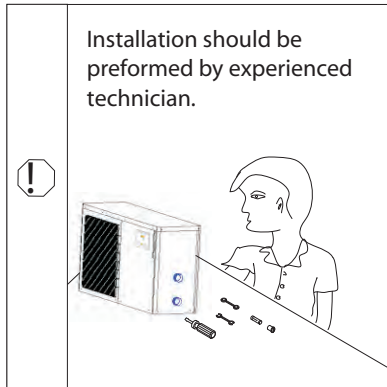



## Technical Specifications

1/2 HP Water Chiller	
Volts	120-60 Hz
Watts	510
BTU' s of Cooling	5,115
Amps	4.4
Weight	50 lbs
Inlet Fitting Size	1 in
Outlet Fitting Size	1 in
Refrigerant	R410A
Recommended Water Pump	EcoPlus 1056 gph
Recommended Tank Size (hydroponic application)	100 gal
Recommended Tank Size (aquarium application)	100-250 gal

NOTE: High ambient air temperatures will decrease cooling capacity.

1 HP Water Chiller	
Volts	120-60 Hz
Watts	870
BTU's of Cooling	8,525
Amps	8
Weight	63 lbs
Inlet Fitting Size	1 in
Outlet Fitting Size	1 in
Refrigerant	R410A
Recommended Water Pump	EcoPlus 1056 gph
Recommended Tank Size (hydroponic application)	200 gal
Recommended Tank Size (aquarium application)	200-400 gal

NOTE: High ambient air temperatures will decrease cooling capacity.

1 1/2 HP Water Chiller	
Volts	120-60 Hz
Watts	1150
BTU's of Cooling	11,935
Amps	10.5
Weight	88 lbs
Inlet Fitting Size	1 in
Outlet Fitting Size	1 in
Refrigerant	R410A
Recommended Water Pump	EcoPlus 1267 gph
Recommended Tank Size (hydroponic application)	300 gal
Recommended Tank Size (aquarium application)	300-500 gal

NOTE: High ambient air temperatures will decrease cooling capacity.

### Remarks:

1. The recommended water volume is closely related to the ambient temperature and the required water temperature. When the ambient temperature is high, while a low temperature is required, the water volume should be reduced to achieve the best efficiency.
2. The above refrigerating capacity is tested under the condition of the ambient Temp 89.6° F and water temp 82.4° F. The refrigerating capacity may vary if the testing condition changes.
3. Refrigerating effect will be impacted by ambient temperature, flow rate of the water circulation, installation position, lighting system, surrounding heat sources etc. To get the best use of this machine, please follow strictly this instruction manual for installation
4. We reserve the right of revising the above model. No special notification will be announced for minor changes.



## How to select the right chiller?

As the first step, get to know the water volume of your aquarium or reservoir.

The most important factors to be considered is the lowest water temperature you expect and the ambient temperature.

The other factors such as ventilation, structure of your aquarium or reservoir, water flow rate are the secondary to be considered as they are easier to improve.

In the table above, "recommended water volume" is provided with the maximum and minimum water volume.

If the ambient temperature is 89.6° F and you expect to cool the water to the temperature more than 71.6° F, choose the chiller based on the maximum water volume.

While if you expect to cool the water to the temperature between 60.8 -71.6° F choose the chiller based on the minimum water volume.

If you need to further lower temperature, you should consider a higher power chiller, or reducing the water volume.

The below performance curves below is for the user's reference in choosing the right machine.



# Performance Curve

### 1/2 HP #728707

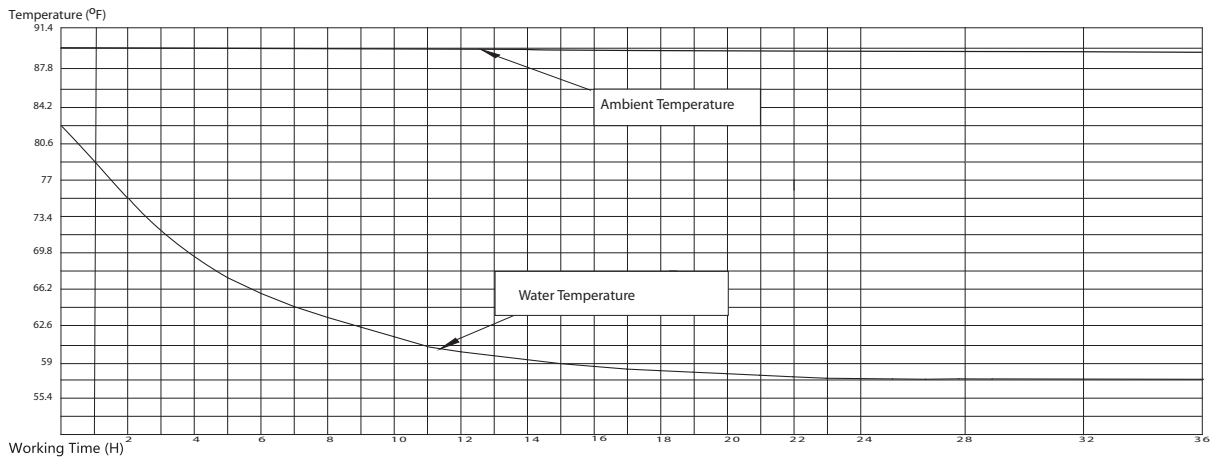

**Test Condition**  
Water Volume: 132gal  
Flow Rate: 555gal/H

### 1 HP #728708

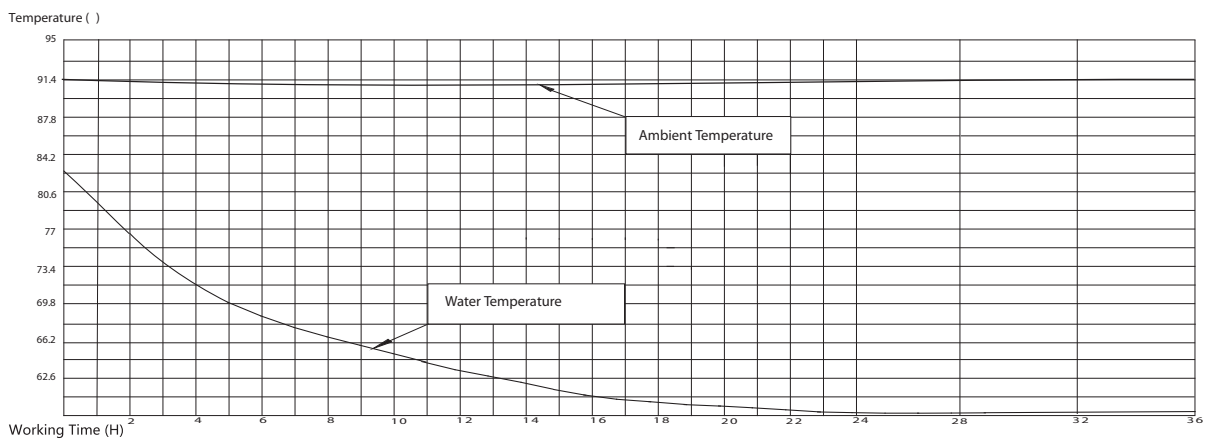

**Test Condition**  
Water Volume: 264gal  
Flow Rate: 1,320gal/H

### 1 1/2 HP #728709

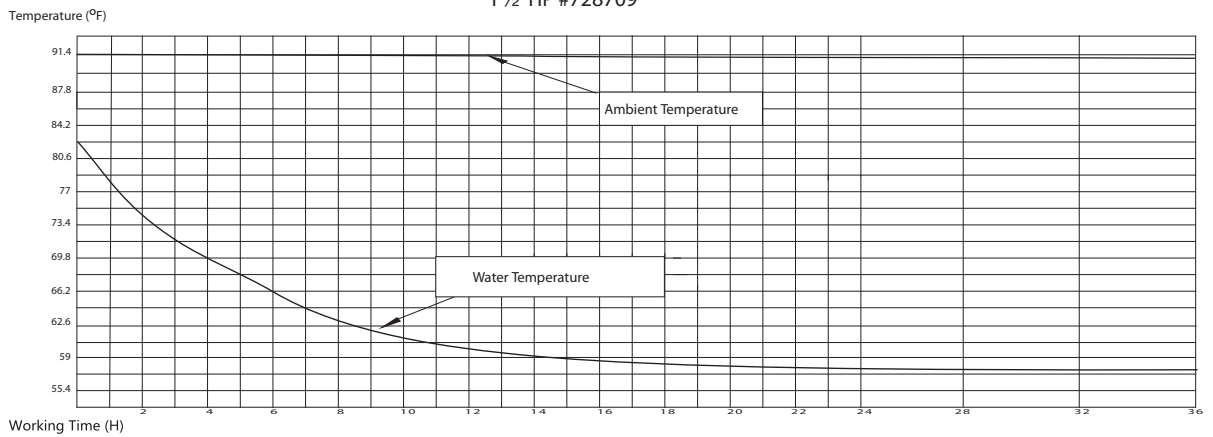

**Test Condition**  
Water Volume: 396gal  
Flow Rate: 1,320gal/H

# Installation

The installation of the chiller must comply with the safety precautions and warnings. The unit must be used with a circulating system and a filtering system. As outlined below: aquarium or reservoir -- filtering system or filter -- water pump -- inlet of chiller/warmer -- outlet of chiller/warmer -- aquarium/reservoir.

## Installation diagram

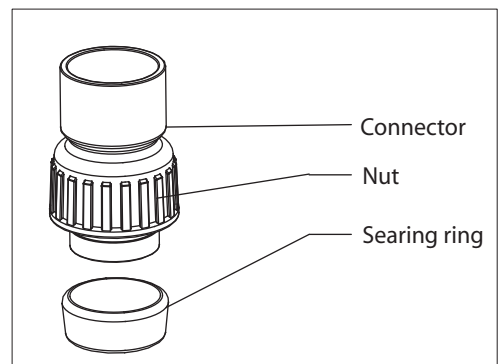
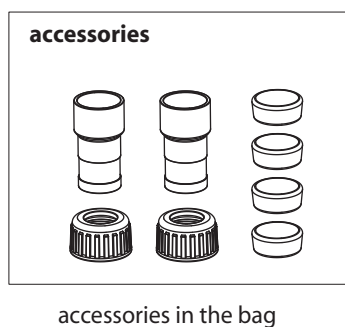
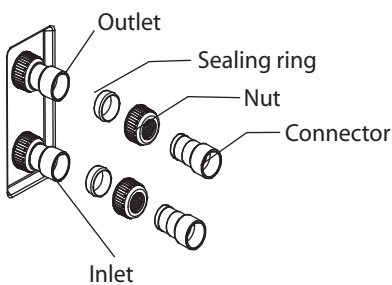
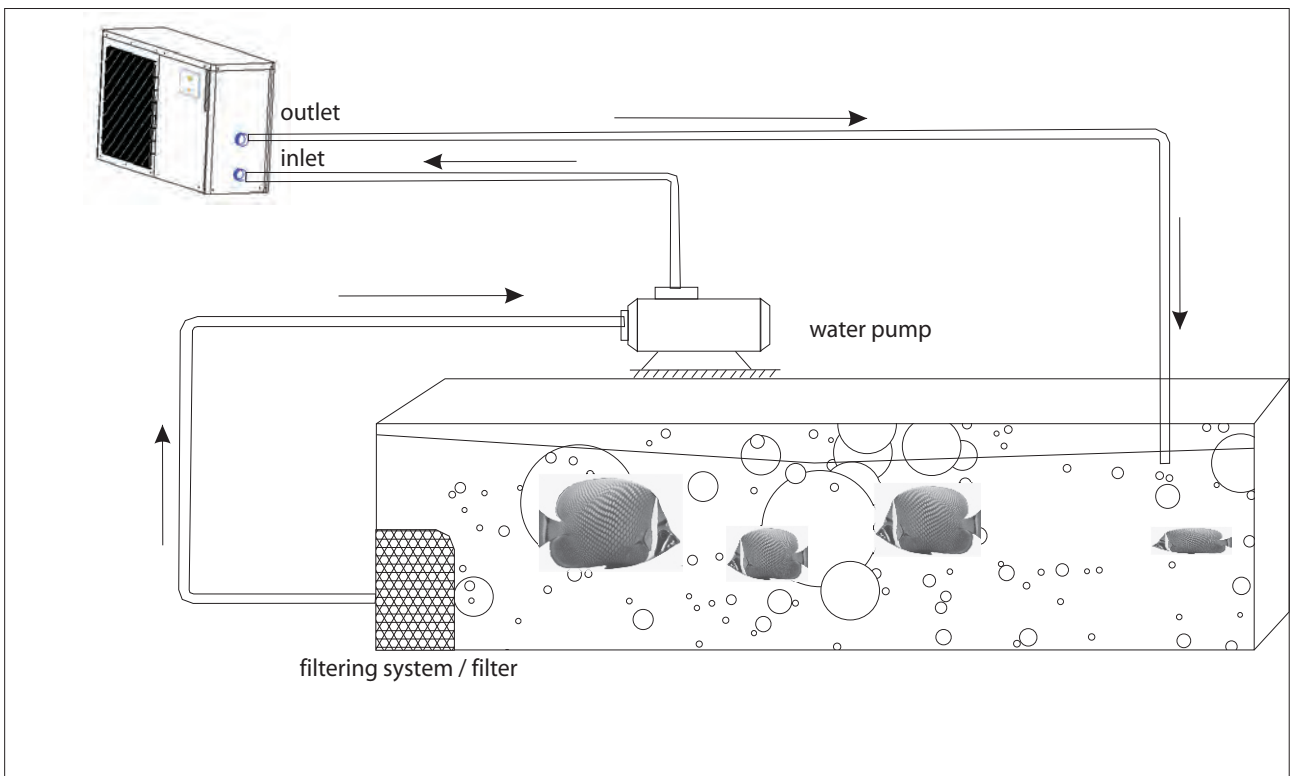

Insert the connector and rubber ring into the nut.



## Installation

The product has two terminals on one end, with the bottom one for inlet and the top for outlet. Connection of the aquarium/reservoir and water pump can be made with either soft or hard tubing (for high water flow, hard tubing is better). For the tubing diameter please refer to the diameter of the connector supplied. When using soft tubing, make sure there is no bending, entanglement or pressure applied to the tube, as this may block the water flow.

The outlet tube going to the aquarium/reservoir shall be positioned slightly above the water level and securely fixed. Inlet tube should be positioned at 1.97 in~3.94 in above the bottom of aquarium/tank. It is best to have inlet and outlet positioned at opposite sides of the aquarium/reservoir.

The chiller unit must be installed in a location with good ventilation. Keep the clearance of at least 11.8 in for the front and two sides (ventilation inlet) and at least 19.68 in for the back (ventilation outlet). More clearance should be provided when the machine works in high power. Otherwise, the cooling will be less because of the poor ventilation, and cause abnormal operation of the machine.



## Operation

Before operation, please check the following:

- A) Whether the water inside the aquarium or reservoir is suitable and the inlet and outlet are securely installed.
- B) Check for leakage with any tube terminals.
- C) Make sure power plug and connecting terminals are securely connected.
- D) Turn on the water pump to make sure the tank inside the chiller, circulating system, and filtering system function normally without any blockage.

The machine is operated by the intelligent micro computer, with functions of control, delayed protection, freeze prevention, over current protection, power loss memory and defrost.

The water temp is maintained at set-up temp, with a tolerance of  $\pm 2$ .

- E) In the event of a power failure the unit will auto re-start when the power is turned on.

## Operation

### **(1) Temp setting:**

- Press "SET" to enter setting feature, digital control switch, display pre-set temperature;
- Press ▲ to turn up pre-set temp, press ▼ to turn down pre-set temp;
- Stop pressing any key for 6 seconds, digital control panel will exit to temperature display, and the setting takes effect. The machine will start refrigerating automatically.

### **(2) Calibrating of the temperature**

If the displayed water temp is different from the actual water temp, calibrating the digital display as below:

- Press and hold "SET" for 10 seconds to enter temp error adjustment function, digital displayer will be showing "CA".
- Press ▲ or ▼ to adjust temp, 1 per time, adjusting range is +4 to -4 ;
- After finishing temp error adjustment, stop pressing any key for 10 seconds, digital control panel will exit to show the adjusted temperature.

### **(3) Automatic failure display:**

If the machine can not detect water temp, digital display will show "E". Please check if the temp sensor is well connected with the machine.

### **(4) Light indicator:**

- Power (Yellow): power is connected and machine is in stand-by mode;
- Cooling (Green): twinkle, in delayed start mode; on, in cooling mode;

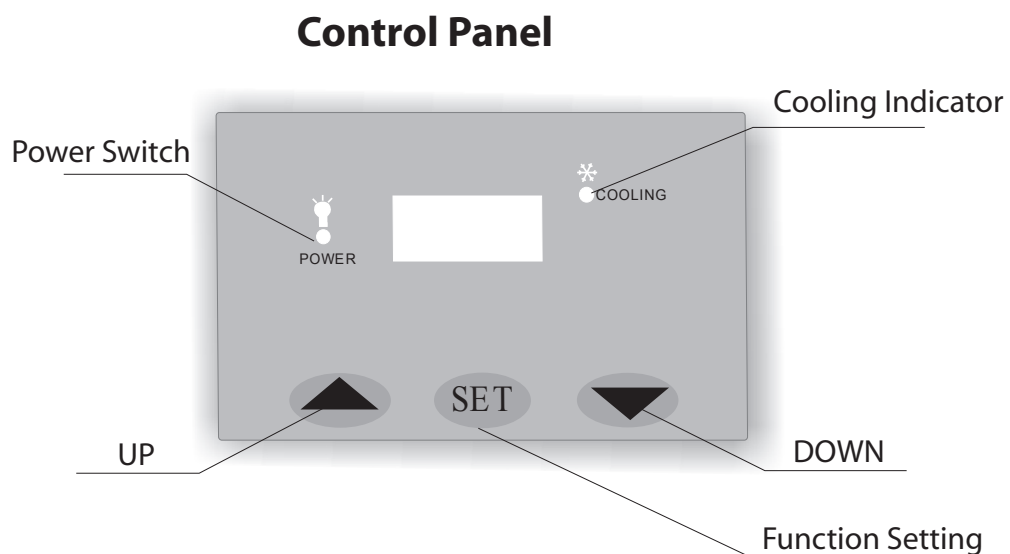





# Maintenance Precautions

Do not tilt or lay the machine on its back. If the machine has been tilted or laid, please position it upright and wait 30 minutes before restart.

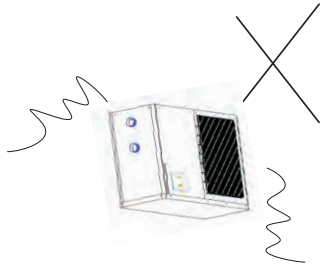

Control panel and motor must be kept dry. If water or any liquid is found on the chiller, please turn off the power immediately and wipe it off with cloth before restarting.

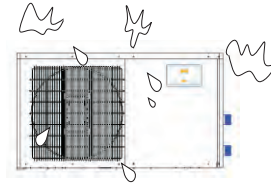

To maintain the best refrigerating efficiency, circulating and filter system should be cleaned once every month, including tubes, fittings, filter media, titanium tube inside the machine and others. Please cut off power first and then clean with warm water, toothbrush and cloth.

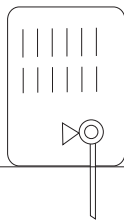

To prevent dust accumulation around inlet/outlet terminals which may reduce refrigerating/heating efficiency, please clean the terminals with a small vacuum or a towel regularly. Do not wash it with water or any forms of liquid.

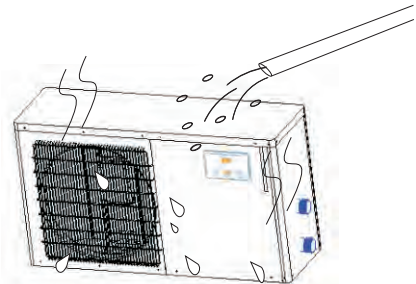

Repairing-Do not attempt to service this unit yourself as opening or removing covers may expose you to dangerous voltage or other hazards. Refer servicing to qualified service personnel for service or replacing all electrical parts.

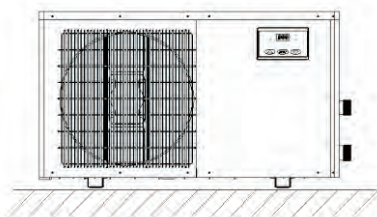

If the machine will not be used for a long period of time, unplug the power cord, clean inlet/ outlet terminals wait till dry (especially the parts may touch water), put it into a poly bag and carton , store it in safe place.

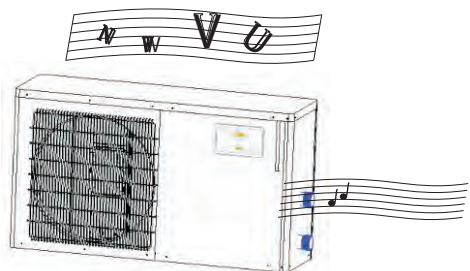



# Circuit Diagram

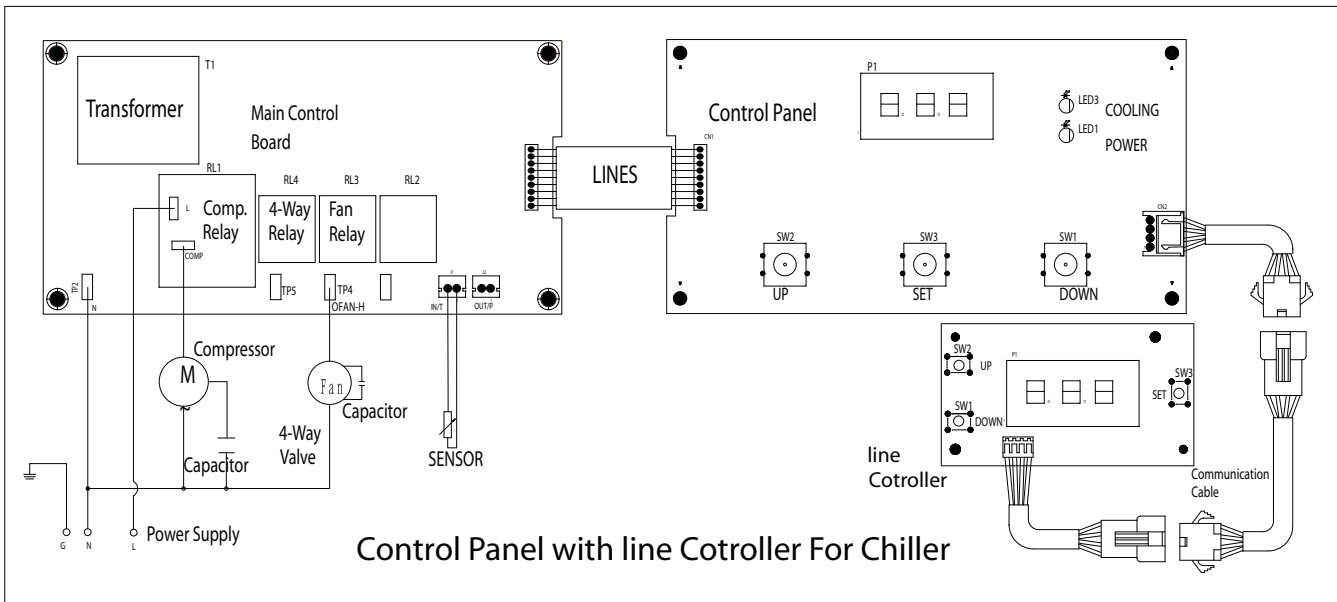
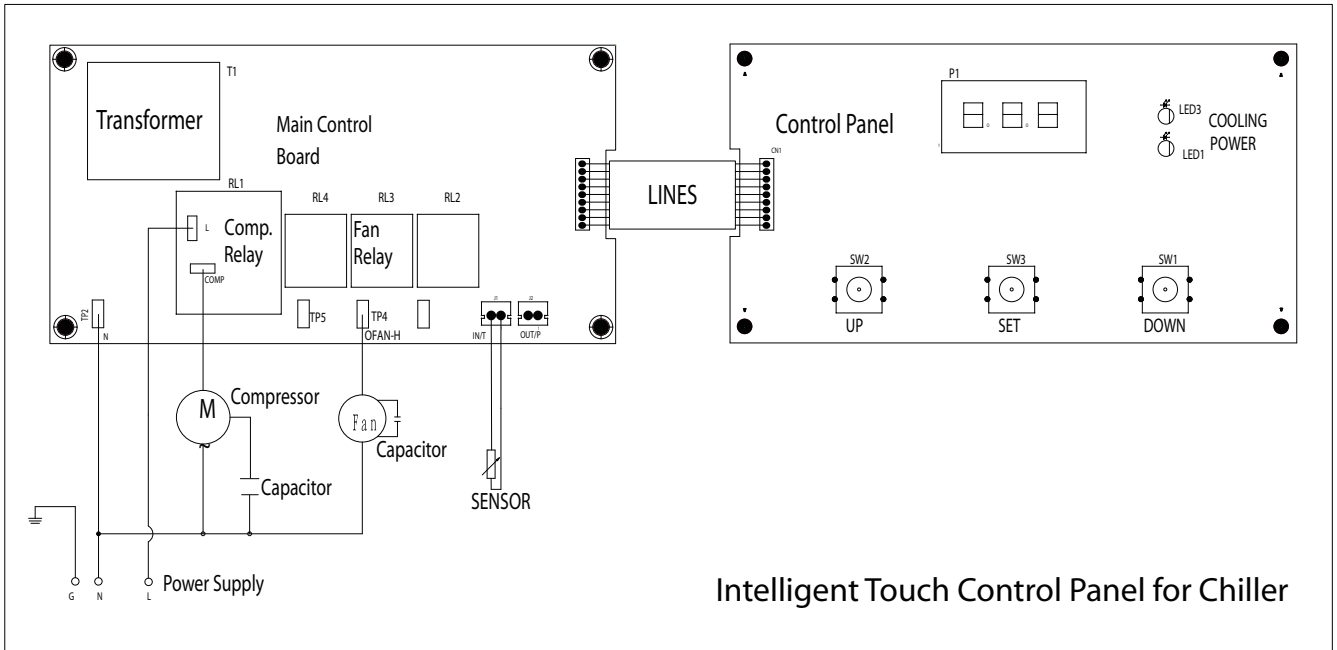

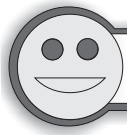

## Trouble Shooting

Failures may be caused by improper operation or maintenance. Before sending the defective products for repair, check the lists below.

Failure	Possible cause	Check Point
Machine not working	Broken circuit of fuse or air switch; bad connection of power cord; power supply problem	Change fuse, check the power switch, plug, connecting terminal; check if voltage and frequency comply with the rated.
Fan rotating, but compressor not working	Compressor terminal not securely connected; compressor interior problem (coil winding, valve); voltage too low; compressor heat protector or capacitor failure	Check the cord connecting terminal; change compressor; increase voltage (+/- 10%); change capacitor or heat protector
Not refrigerating, compressor working on and off frequently	Improper installation lead to poor heat dissipation; radiating fin of condenser blocked by dust; surrounding temperature too high	Adjust installation position to allow enough space for heat dissipation; clean the radiating fin; improve heat dissipation
Not refrigerating or not enough refrigerant	Refrigerant Leakage or not enough refrigerant; improper machine type (in refrigerating capacity); spiral pipe of the evaporator is blocked to lower heat exchange	Check the pipe system; increase refrigerant; welding the leakage place; clean the circulation system and evaporator; reduce the water volume referring to the specifications.
Water temp reaching set-up tem, but the machine continues to run	Temperature sensor not installed at right place or not well concealed; temperature sensor failed;	Check the temperature sensor is installation; turn off or replace the heating switch; refer to operating method for adjusting temperature control
Evaporator leaks	Bad welding of the inlet and outlet; too much head height from the water pump; not installed on level ground causing machine to shake when operating	Have skilled technician weld leakage area; change to more suitable water pump; improve the placement of machine

# Warranty Card

**Product** \_\_\_\_\_

**From which shop** \_\_\_\_\_

**Shop Address** \_\_\_\_\_

**Date of purchase** \_\_\_\_\_ / \_\_\_\_\_ / \_\_\_\_\_

**Shop signature** \_\_\_\_\_

**Purchaser signature** \_\_\_\_\_

The product is warranted to be free of defects in manufacturing and material for one (1) year from the date of purchase.

Please retain your dated original receipt or invoice as proof of purchase, and return the defect to place of purchase.

Please note that, this warranty does not cover damage from accident, misuse or abuse. It also specifically excludes incidental or consequential damages like any loss of fish, plants or other livestock as a result of any failure or defect of this product.





Sunlight Supply, Inc.

National Garden Wholesale®

[www.sunlightsupply.com](http://www.sunlightsupply.com)